

THIS DOCUMENT CONTAINS PROPRIETARY INFORMATION WHICH IS THE PROPERTY OF QSC AUDIO PRODUCTS, THAT MAY NOT BE DISCLOSED, REPRODUCED OR USED WITHOUT EXPRESS WRITTEN CONSENT FROM QSC AUDIO PRODUCTS.

REVISIONS					
REV	ECO	DESCRIPTION	BY	EFF DATE	ISSUED
B	13080	ADD MOUNTING INFORMATION	VU	16-SEP-13	DD

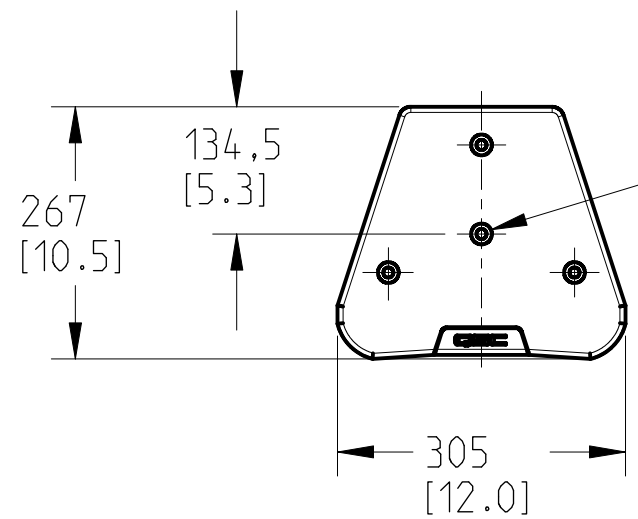

MOUNTING LOCATION TOP/BOTTOM USES M10 FASTENER

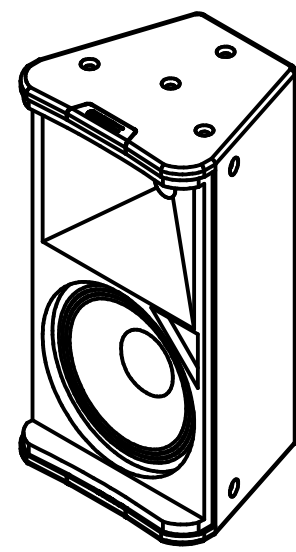
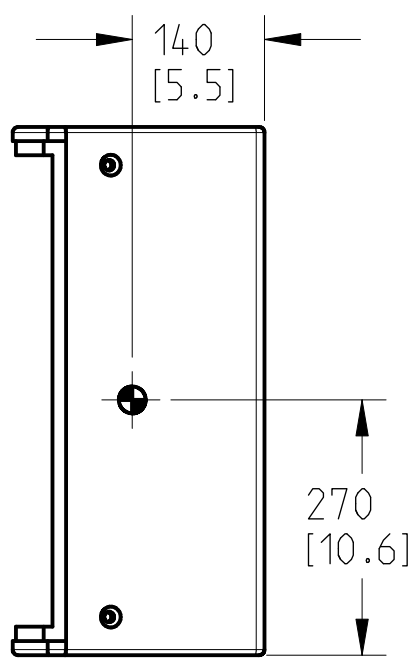
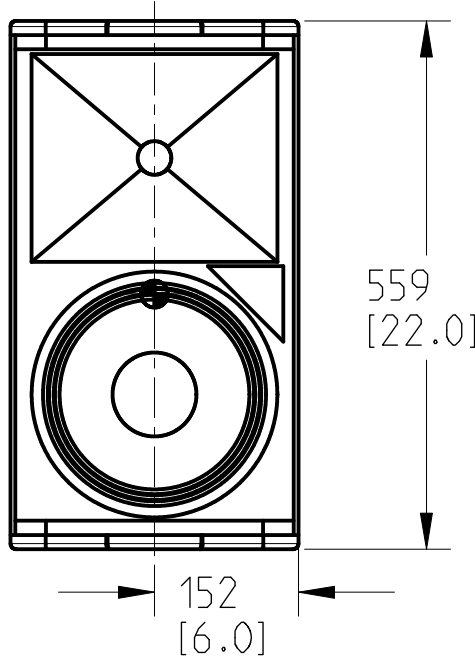

AP-5102

- 5. PARTS ARE SYMMETRICAL ABOUT CENTER LINES UNLESS OTHERWISE NOTED.
 - 4. SYMBOL INDICATES CENTER OF BALANCE.
 - 3. SYMBOL INDICATES SUSPENSION POINT, 15 TOTAL: M10-1.5 THD.
 - 2. TOLERANCES (MM): X ± 5, ANGLES: ± 1°.
 - 1. NET WEIGHT APPROX. 21.8 KG (48 LBS)
- NOTE: UNLESS OTHERWISE SPECIFIED

UNLESS OTHERWISE SPECIFIED DIMENSIONS IN MILLIMETERS (IN)		
TOLERANCES ARE:		
DECIMALS	DECIMALS	ANGLES
.X±.5[.02]	.XX±.25[.010]	± 1/2
DEBURR EDGES .25 [.010] R MAX		
MATERIAL		
FINISH		

APPROVALS	DATE (DD-MMM-YY)
DRAWN J. DELARM	08-OCT-11
CHECKED P. SANCHEZ	15-OCT-12
MFG ENG	-
QA CHECK	-
DRAWING INFO: FG-010230-2D.B.3	
MODEL INFO: FG-010230-3D.B.0	

		QSC AUDIO PRODUCTS, LLC 1675 MACARTHUR BOULEVARD COSTA MESA, CA 92626	
SPEAKER, FINISHED, AP-5102			
SIZE	CAGE CODE	DRAWING NO.	REV
B	00PW 4	FG-010230-2D	B
SCALE:	0.125	DO NOT SCALE DRAWING	SHEET 1 OF 1